



CHRIST CHURCH GRAMMAR SCHOOL

YEAR 12

PHYSICS STAGE 3

MOCK EXAMINATION 2010

--

1			
2			
3			
Total		/ 180 =	%

Time allowed for this paper

Reading time before commencing work: ten minutes

Working time for paper: three hours

Materials required/recommended for this paper

To be provided by the supervisor

Question/Answer Booklet

Formulae and Constants Sheet

To be provided by the candidate

Standard items: pens, pencils, eraser, correction fluid, ruler, highlighters

Special items: non-programmable calculators satisfying the conditions set by the Curriculum Council for this course.

Important note to candidates

No other items may be taken into the examination room. It is **your** responsibility to ensure that you do not have any unauthorised notes or other items of a non-personal nature in the examination room. If you have any un-authorised material with you, hand it to the supervisor **before** reading any further.

Structure of this paper

Section	Number of questions available	Number of questions to be answered	Suggested working time (minutes)	Marks available	Percentage of exam
Section One: Short Answers	17	17	45	54	30 %
Section Two: Problem-Solving	8	8	90	90	50 %
Section Three: Comprehension	2	2	45	36	20 %
					100

Instructions to candidates

Write your answers in this Question/Answer Booklet

Working or reasoning should be clearly shown when calculating or estimating answers.

You must be careful to confine your responses to the specific questions asked and to follow any instructions that are specific to a particular question.

**YEAR 12
PHYSICS STAGE 3
MOCK EXAMINATION 2010**

Section One: Short Response

This section has **seventeen (17)** questions. Answer **all** questions. Write your answers in the space provided.

Suggested working time for this section is **45 minutes**.

This Page Has Been Left Blank Intentionally

Question 1**(2 marks)**

An object moves in a circle in a counter-clockwise direction with constant speed. On the diagram below draw and label the correct velocity and acceleration vectors for the object.

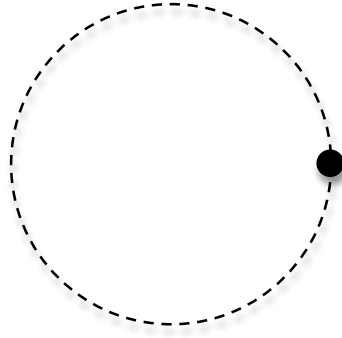
**Question 2****(2 marks)**

A member of the Σ group of particles consists of two u quarks and an s quark. What is its charge?

Question 3**(3 marks)**

A 1.50 m long rope is stretched between two supports with a tension that makes the speed of transverse waves 48.0 ms^{-1} . What is the frequency of the second overtone?

Question 4**(4 marks)**

A current is sent through a helical coil spring, as shown in the diagram below. When the current is flowing the spring contracts, as though it had been compressed. Explain why this is so. [Hint: it may be a good idea to annotate and make reference to the diagram in your answer or even draw an alternative diagram].

**Question 5****(4 marks)**

The laser bar-code scanners used at supermarkets emit orange-red light of wavelength 633 nm. If the laser in a typical bar-code scanner emits 1.00 mW of light energy, how many photons are emitted per second?

Question 6**(4 marks)**

Explain, with the aid of appropriate estimations and calculations, why it is easier to hold a 10.0 kg dumbbell in your hand at your side (i) than to hold it with your arm extended horizontally (ii).

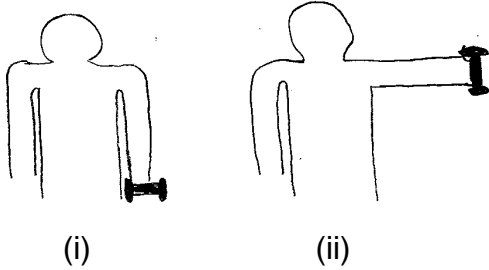
**Question 7****(2 marks)**

The sixth harmonic is set up in a pipe. How many open ends does the pipe have? Explain your reasoning.

Question 8**(1 mark)**

What is the quark makeup of the antiproton?

Question 9**(5 marks)**

A sheet of copper is placed between the opposite poles of a strong magnet with the magnetic field perpendicular to the sheet, as shown in the diagram below.

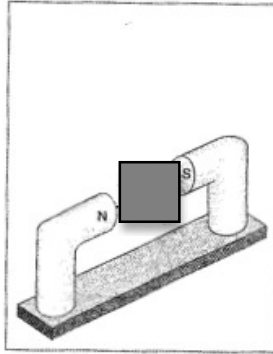

A large force is required to pull the copper sheet out. Will the force required (circle your chosen response):

(1 mark)

- A. Decrease when the speed of the pull is increased?
- B. Increase when the speed of the pull is increased?
- C. Not be affected by the speed of the pull?

Explain your reasoning.

(4 marks)

Question 10**(3 marks)**

What three key observations provide evidence for the Big Bang theory?

Question 11**(4 marks)**

The fast train known as the TGV (Train à Grande Vitesse) that runs south from Paris, France, has a scheduled average speed of 216 kmh^{-1} . If the train goes around a curve at that speed and the acceleration experienced by the passengers is to be limited to 0.050 g , what is the smallest radius of curvature the train can travel around?

Question 12**(3 marks)**

Two identical loudspeakers are positioned 4.00 m apart. The loudspeakers are driven by the same amplifier and thus produce waves that are in phase. If walking from A to B, 3 soft spots are passed through and a loud spot is heard at B, what is the frequency of the sound?

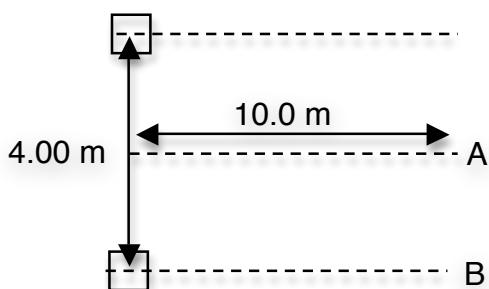

Question 13**(4 marks)**

An alien spacecraft is flying overhead at a great distance as you stand in your backyard. You see its searchlight blink on for 0.190 s.

- (a) Would an alien observer on the spacecraft measure the same time interval for the searchlight blinks that we measure on Earth?

(1 mark)

- (b) Would the time between blinks that we measure on Earth be longer or shorter than what the alien measures on the spacecraft? Explain your reasoning.

(3 marks)

Question 14**(4 marks)**

Hundreds of thousands of asteroids orbit the sun within the *asteroid belt*, which extends from about 3.00×10^8 km to about 5.00×10^8 km from the surface of the sun. Assume the orbits are circular. Find the speed of an asteroid at the inside of the belt.

Question 15**(3 marks)**

The wavelength of the H_{β} line in the spectrum of the star Megrez in the constellation Ursa Major (the Great Bear) is 486.112 nm. Laboratory measurements demonstrate that the normal wavelength of this spectral line is 486.133 nm. Is the star coming towards us or moving away from us – explain your reasoning.

Question 16**(3 marks)**

A beam of 35.0 keV electrons strike a molybdenum target, generating X-rays. Determine the cutoff wavelength (λ_{\min}).

Question 17**(3 marks)**

The ‘antimatter’ drive is a staple of many science fiction spacecraft (for example the Starship Enterprise). If 400 kg of antimatter ‘fuel’ combines with 400 kg of matter, how much energy would be released?

End of Section One

This Page Has Been Left Blank Intentionally

**YEAR 12
PHYSICS STAGE 3
MOCK EXAMINATION 2010**

Section Two: Problem-Solving

This section has **eight (8)** questions. Answer **all** questions. Write your answers in the space provided.

Suggested working time for this section is **90 minutes**.

NAME: _____

This Page Has Been Left Blank Intentionally

Question 1**(10 marks)**

A 10.0 g button is placed on a horizontal rotating platform of diameter 32.0 cm. The button will revolve with the platform when it is brought to a speed of 40 rev/min, provided the button is not more than 15 cm from the centre axis.

(a) What is the speed of the button in ms^{-1} ?

(3 marks)

(b) What is the friction between the button and platform?

(3 marks)

(c) If the speed of revolution increased would the button's radius increase, decrease or stay the same? Explain your reasoning.

(4 marks)

Question 2**(7 marks)**

Two people carry a heavy box by placing it on a uniform 200 N board which is 2.00 m long. One person lifts at one end with a force of 400 N and the other lifts at the opposite end with a force of 600 N.

(a) What is the mass of the box?

(3 marks)

(b) Where is the centre of gravity of the box located?

(4 marks)

Question 3**(15 marks)**

The planet Uranus has a radius of 25,560 km and a surface acceleration due to gravity of 11.1 ms^{-2} at its poles. Its average distance from the Sun is about 2.87×10^9 km.

(a) How long does it take light from the Sun to reach Uranus?
(2 marks)

(b) Determine the mass of Uranus from this data.
(3 marks)

The moon Miranda (discovered by Kuiper in 1948) is in a circular orbit around Uranus at an altitude of 104,000 km above the planet's surface.

Miranda has a mass of 6.60×10^{19} kg and a radius of 235 km.

(c) Determine the magnitude of Miranda's acceleration due to its orbital motion around Uranus.
(4 marks)

- (d) Determine the magnitude of the acceleration due to gravity at the surface of Miranda.

(3 marks)

- (e) Do the answers to part (b) and (c) mean that an object released 1.00 m above Miranda's surface would fall 'up' relative to Miranda? Explain your reasoning.

(3 marks)

Question 4**(14 marks)**

A truck drives onto a drawbridge (a bridge which can be raised to allow for the passage of tall boats underneath) and stalls with its centre of gravity three quarters of the way across the span of the bridge. While the truck driver is waiting for help, a boat approaches and the bridge starts to raise by means of a cable attached to the end opposite the hinge.

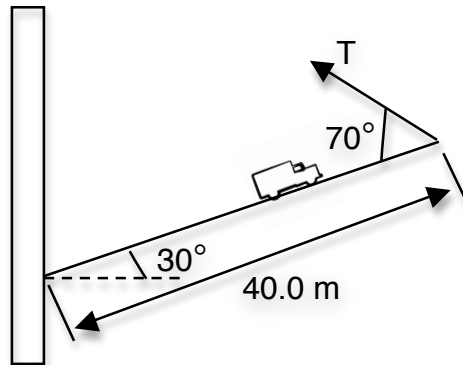

The uniform bridge is 40.0 m long and has a mass of 12.0×10^3 kg. The truck has a mass of 30.0×10^3 kg. When the bridge is raised to an angle of 30.0° above the horizontal, the cable makes an angle of 70.0° with the surface of the bridge.

(a) What is the tension in the cable?

(4 marks)

- (b) What is the reaction force the hinge exerts on the bridge (when the bridge is in the position shown in the diagram on page 19)? [Hint: the cable is at an angle of 40.0° to the horizontal].

(6 marks)

- (c) If the truck driver takes off the hand brake and starts to roll back down the bridge, what will happen to the magnitude of the tension in the cable. Explain your reasoning.

(4 marks)

Question 5**(7 marks)**

A straight piece of conducting wire of mass 100 g and length 20.0 cm is placed on a frictionless incline tilted at an angle of 20.0° to the horizontal. There is a uniform, 0.50 T magnetic field perpendicular to the incline and directed out of the incline at all points, as shown in the diagram below.

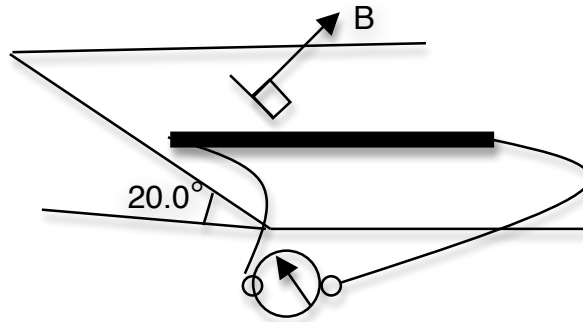

To keep the wire from sliding down the incline, an adjustable voltage source is attached to the ends of the wire. When the correct amount of current flows through the wire it remains at rest.

- (a) On the diagram above indicate the direction of the current required to keep the wire at rest. (1 mark)
- (b) Determine the magnitude of the current required to keep the wire at rest. (3 marks)
- (c) If the magnetic field is now altered to point upwards in a vertical direction, would the amount of current required to keep the wire at rest, increase, decrease or stay the same? Explain your reasoning. (3 marks)

Question 6**(11 marks)**

Aircraft experience a lift force (due to the air) that is perpendicular to the plane of the wings. Light airplanes are carefully designed so that their wings can safely provide a lift force of 3.80 times the weight of the airplane. A force greater than this can damage the structure of the wing. When an airplane is to complete a horizontal turn it must bank – this means the wings will tilt relative to the horizontal, as shown in the diagram below.



- (a) On the diagram above, draw and label the vertical forces acting on the plane (i.e ignore thrust and air resistance).
(2 marks)
- (b) What force is providing the centripetal force to enable the plane to turn?
(1 mark)
- (c) What is the maximum banking angle that a pilot can maintain?
(3 marks)
- (d) What angle must the wings be tilted for the airplane to execute a horizontal turn of radius 1.20 km, if the plane is flying at a constant speed of 240 kmh^{-1} ?
(5 marks)

Question 7**(13 marks)**

Many accelerators use magnets to deflect charged particles into circular paths. An example is the cyclotron, a cross-section through which is shown below. Particles of mass, m and charge q move inside a vacuum chamber in a uniform magnetic field, such that the magnetic field is perpendicular to the plane of their paths and directed out of the page.

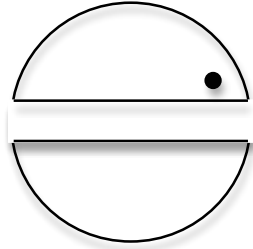

- (a) Show that the relationship between the radius of the charged particles path, its mass, charge and speed and the magnetic flux density is

$$\text{given by } r = \frac{mv}{qB}.$$

(2 marks)

- (b) Will a **positively** charged particle (as indicated by the dot on the diagram above) be travelling in a clockwise or anticlockwise direction?

(1 mark)

An alternating potential difference is applied between the two electrodes (called dees), creating an electric field in the gap in between them. The polarity of the potential difference is changed precisely twice each revolution. As the charged particles pass through the electric field, their radius is increased.

- (c) On the diagram above draw in the direction of the electric field as the particle moves through the gap between the dees.

(1 mark)

- (d) Why does the direction of the electric field need to change **twice** each cycle?
(2 marks)
- (e) Explain why the radius of the charged particle will increase as the charged particle moves through the electric field.
(3 marks)
- (f) A cyclotron is to accelerate protons to an energy of 5.40 MeV. The superconducting electromagnet of the cyclotron produces a 3.50 T magnetic field. If the protons have achieved a kinetic energy of 2.70 MeV, what is the radius of their circular orbit?
[4]

Question 8**(13 marks)**

To tune a violin, the violinist first tunes the A string to the correct pitch of 440 Hz and then bows the A and E strings simultaneously and listens for a beat pattern. While bowing the strings, the violinist hears a beat frequency of 3.00 Hz and notices that the beat frequency increases as the tension on the E string increases. The E string needs to be tuned to 660 Hz.

- (a) Explain with the aid of suitable diagrams, why the beats occur.
(4 marks)

- (b) Which harmonics of the A and E strings could be causing these beats?
(2 marks)

- (c) What is the frequency of the E string vibration when the beat frequency is 3.00 Hz?
(2 marks)

- (d) Should the violinist tighten or loosen the E string to tune it to 660 Hz?
Explain your reasoning.
(3 marks)
- (e) Tension of a string is related to the speed of a wave on a string by the formula $v = \sqrt{\frac{mT}{L}}$ where m and L are the mass and length of the string respectively and T the tension in the string. If the tension of the E string was 80.0 N for the 3.00 Hz beat pattern, what tension is required for perfect tuning?
(2 marks)

End of Section Two

This Page Has Been Left Blank Intentionally

This Page Has Been Left Blank Intentionally

**YEAR 12
PHYSICS STAGE 3
MOCK EXAMINATION 2010**

Section Three: Comprehension

This section has **two (2)** questions. Answer **all** questions. Write your answers in the space provided.

Suggested working time for this section is **45 minutes**.

NAME: _____

This Page Has Been Left Blank Intentionally

Question 1**(18 marks)**The Bohr Theory of Hydrogen – The Rydberg Constant

The spectrum from a hot gas of an element consists of discrete wavelengths that are characteristic of the element. In 1885 in an attempt to understand these spectra, Johann Balmer published an empirical (relying on experimental evidence) relationship which described the visible spectrum of hydrogen (the Balmer series – see Figure 1). The modern equivalent of the Balmer formula is:

$$\frac{1}{\lambda} = R \left(\frac{1}{2^2} - \frac{1}{n^2} \right) \quad n = 3, 4, 5, 6, \dots$$

where: λ is the wavelength of the emitted radiation
 R is the Rydberg constant
 n is the energy level from which decay has occurred.

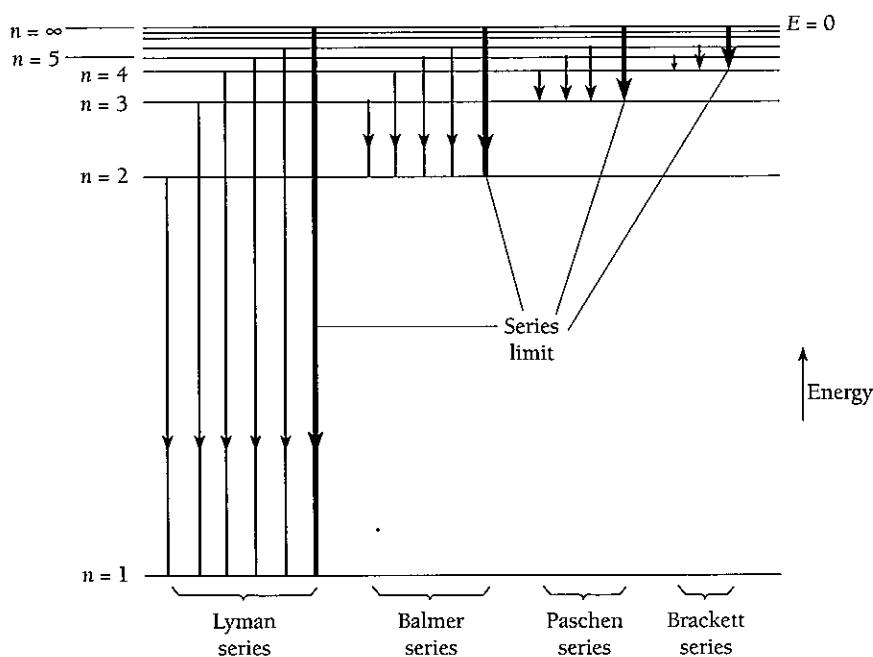

Figure 1: Spectral series of hydrogen.

A group of students undertake an experiment to measure the wavelengths of the Balmer series of hydrogen. They use a spectrometer, diffraction grating and a hydrogen discharge tube as shown in Figure 2.

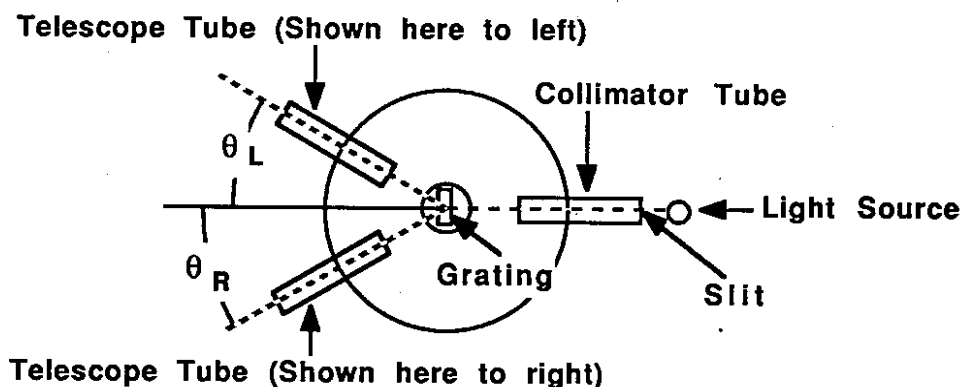

Figure 2: Spectrometer (telescope tube), diffraction grating and hydrogen discharge tube (light source).

A diffraction grating is a piece of transparent material on which has been ruled a large number of equally spaced parallel lines. The distance between the lines is called grating spacing, d , and it is usually only a few times as large as a typical wavelength of visible light. Light rays that strike the transparent portion of the grating (between the ruled lines) will pass through the grating at an angle with respect to their original path. For a given wavelength there will exist a series of angles at which an image is formed. The relationship between wavelength, grating spacing and angle of diffraction is given by:

$$\lambda = d \sin \theta$$

In this experiment the diffraction grating had 1.26×10^4 rulings spaced over 25.4 mm.

The results the students recorded are given in the table below:

θ_L ($^\circ$)	θ_R ($^\circ$)	θ ($^\circ$)	λ (m)	n		
19.1	18.9					
13.7	14.1					
12.3	12.5					
11.7	11.7					
10.1	10.7					

(a) Determine the value of the grating spacing.

(2 marks)

- (b) For each set of measurements determine the average diffraction angle.
(1 mark)
- (c) Determine the wavelength for each diffraction angle (if you could not obtain an answer for (a) use a value of $d = 1500 \text{ nm}$)
(1 mark)
- (d) Determine which value of n corresponds to each of the wavelengths calculated and include this information in the table on page 32.
(1 mark)
- (e) How should you rearrange the Balmer formula (page 31) to be able to plot a straight line graph?
(1 mark)
- (f) Process your data so you are able to plot a straight line graph.
(1 mark)
- (g) Plot your graph on the graph paper on the next page.
(5 marks)
- (h) Determine the gradient of your graph. What constant should the gradient be equal to?
(4 marks)
- (i) Why would it not be possible for the students to use this equipment to take measurements for decay ending at $n=1$ or $n=3$?
(2 marks)

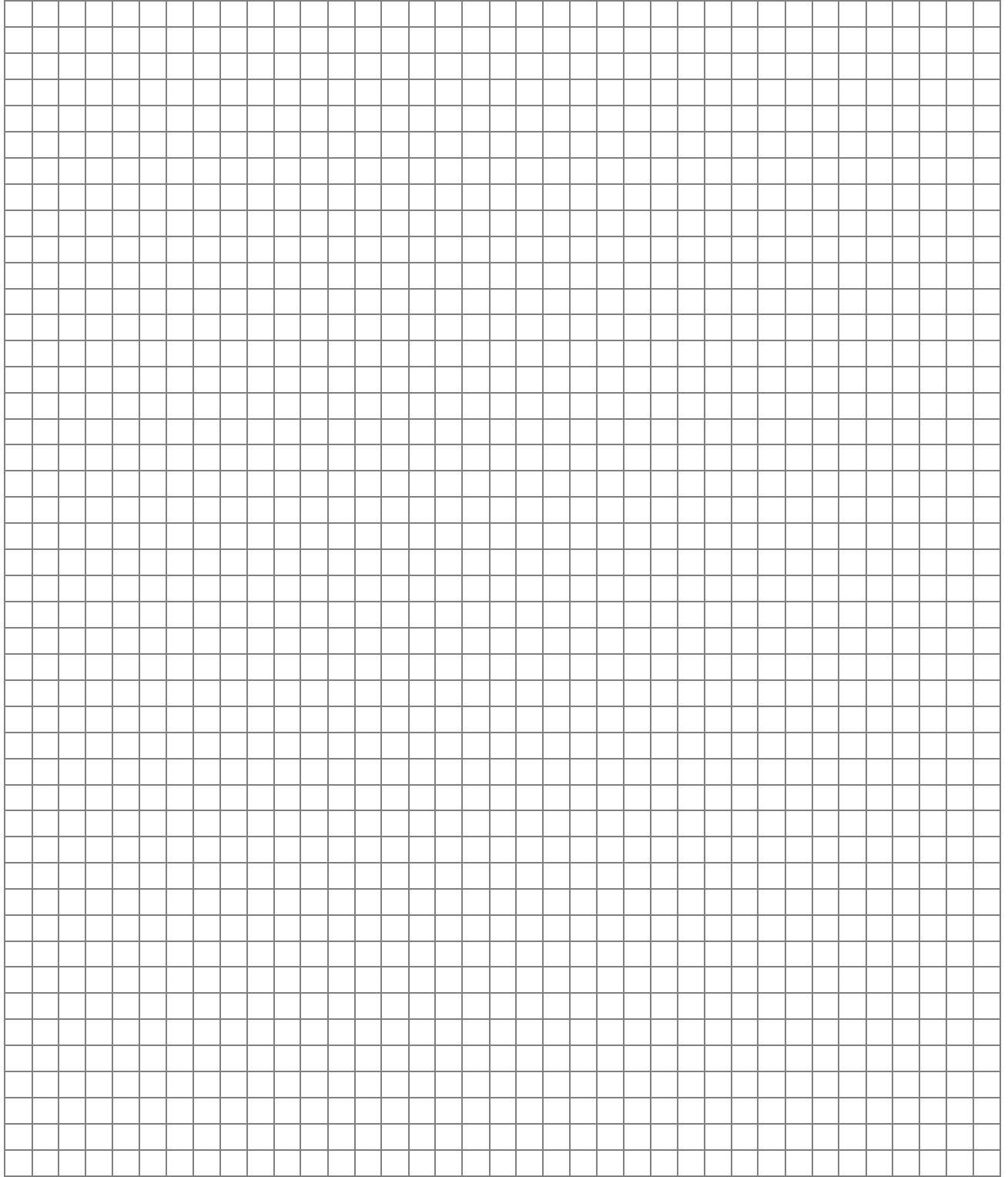

Question 2**(18 marks)****The Laser**

This year the laser celebrated its 50th birthday. When Theodore Maiman, an engineer turned physicist, eked out the first pulses of coherent light from a pink-ruby crystal on 16 May 1960, he could not have imagined that the laser would become such a workhorse of physics and so ingrained in everyday life. Lasers have gone on to become one of the outstanding success stories in physics. They can cool atoms, send data, mend eyes, sharpen astronomical images and probe individual DNA molecules; they may even detect gravitational waves and trigger fusion.

The laser is a device that produces a light beam with some remarkable properties:

1. The light is very nearly monochromatic.
2. The light is coherent, with the waves all exactly in phase with each other.
3. A laser beam hardly diverges at all.
4. The beam is extremely intense. To achieve an energy density equal to that in some laser beams, a hot object would have to be at a temperature of 10^{30} K.

-
- (a) Which of these diagrams correctly illustrates the radiation emitted from a laser and why?

(2 marks)

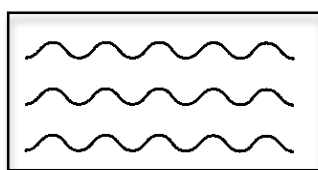

(i)

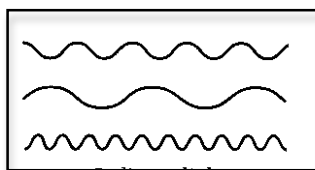

(ii)

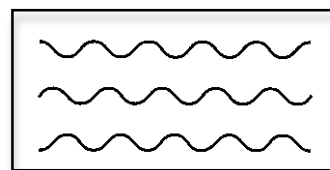

(iii)

The term laser stands for **light amplification by stimulated emission of radiation**. The key to the laser is the presence in many atoms of one or more excited energy levels whose lifetimes may be 10^{-3} s or more instead of the usual 10^{-8} s. Such relatively long lived states are called **metastable** states.

Three kinds of transition involving electromagnetic radiation are possible between two energy levels E_0 and E_1 in an atom as shown in Figure 1.

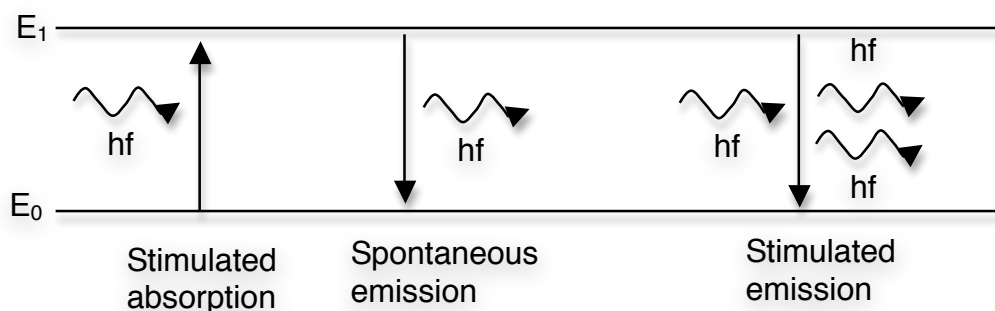

Figure 1: Transitions between two energy levels in an atom

If the atom is initially in the lower state E_0 , it can be raised to E_1 by absorbing a photon of energy $hf = E_1 - E_0$. This process is called **stimulated absorption**.

If the atom is initially in the upper state E_1 , it can drop to E_0 by emitting a photon of energy hf . This is called **spontaneous emission**.

Einstein in 1917 was the first to point out a third possibility, **stimulated emission** in which an incident photon of energy hf causes a transition from E_1 to E_0 . In stimulated emission, the radiated light waves are exactly in phase with the incident ones, so the result is a beam of coherent light. Einstein showed that stimulated emission has the same probability as stimulated absorption ie a photon of energy hf incident on an atom in the upper state E_1 has the same likelihood of causing the emission of another photon of energy hf as its likelihood of being absorbed if it is incident on an atom in the lower state E_0 .

The simplest type of laser is a **three-level laser**, which uses an assembly of atoms or molecules that have a metastable state hf in energy above the ground state and a still higher excited state that decays to the metastable state. What we want is more atoms in the metastable state than in the ground state. If we can arrange this and then shine light of frequency f on the assembly, there will be more stimulated emissions from atoms in the metastable state than stimulated absorptions by atoms in the ground state. The result will be an amplification of the original light.

An example of the three-level laser is the ruby laser. The ruby laser is based on the three energy levels in the chromium ion Cr^{3+} as shown in Figure 2. A ruby is a crystal of aluminium oxide Al_2O_3 in which some of the Al^{3+} ions are replaced with Cr^{3+} ions which are responsible for the red colour.

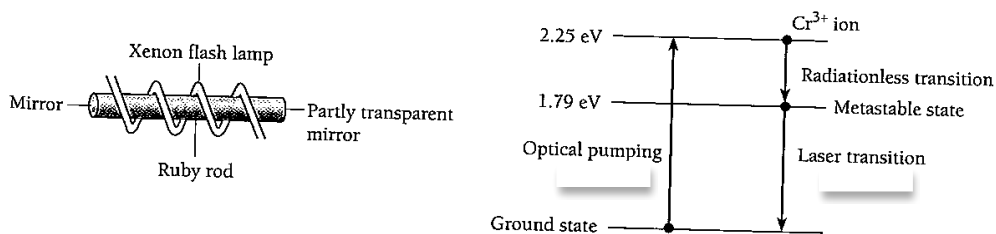

Figure 2

Figure 2: The ruby laser

- (b) In the ruby laser what energy photon is required for the optical pumping?

(2 marks)

- (c) What energy photon is produced in the laser transition?

(2 marks)

The term **population inversion** describes an assembly of atoms in which the majority are in energy levels above the ground state; normally the ground state is occupied to the greatest extent.

A number of ways exist to produce a population inversion. One of them is called **optical pumping**. Here an external light source is used, some of whose photons have the right frequency to raise the ground state atoms to the excited state that decays spontaneously to the metastable state.

Why are three levels needed? If there are only two levels, a metastable state and a ground state, the more photons of frequency f we pump in, the more upward transitions there will be from the ground state to the metastable state. At the same time, however, the pumping will stimulate transitions from the metastable state to the ground state. When half the atoms are in each state, the rate of stimulated emissions will equal that of stimulated absorption, so no more than half the atoms can ever be in the metastable state – laser amplification cannot occur.

For laser action to occur, the medium used must have at least three energy levels.

(d) What must be the nature of each of these three levels?

(3 marks)

(e) Why is three states the minimum number?

(3 marks)

In the ruby laser, a xenon flash lamp excites the Cr^{3+} ions to a level of higher energy from which they fall to the metastable state by losing energy to other ions in the crystal. Photons from the spontaneous decay of some Cr^{3+} ions are reflected back and forth between the mirrored ends of the ruby rod, stimulating other Cr^{3+} ions to radiate. After a few microseconds the result is a large pulse of monochromatic, coherent red light from the partly transparent end of the rod.

- (f) Why would one end of the ruby rod be completely silvered (ie a total reflector) and the other only partially silvered? [Hint: look at Figure 2]
(2 marks)
- (g) A certain ruby laser emits 1.00 J pulses of light whose wavelength is 694 nm. What is the minimum number of Cr^{3+} ions in the ruby?
(2 marks)
- (h) Why would the value calculated in (f) only be the **minimum** number of Cr^{3+} ions?
(2 marks)

End of Section Three

This Page Has Been Left Blank Intentionally